

»R20ES« series



One-hand quick disconnect couplings, one side sealing, extremely compact with a large bore and only a small pressure drop.

To prevent injuries or a "whiplash" effect, we recommend that the plug-in nipple is held with one hand during uncoupling.

Areas of application: Pneumatic system, machine and plant engineering, measurement, monitoring and control systems, manufacturing industry, medical technology, chemical / pharmaceutical industry, automotive, food technology, offshore.

Operating pressure	0 to 35 bar, maximum static working pressure (non-pulsating)
Medium and ambient temperature	-15 °C to 200 °C
Housing	Stainless steel 1.4404
Sleeve	Stainless steel 1.4404
Valve body	Stainless steel 1.4404
Spring	Stainless steel 1.4404
Retaining ring	Stainless steel 1.4404
Ball	Stainless steel 1.4404
Sealant	FKM

Flow values:

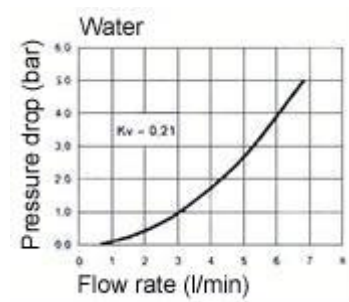
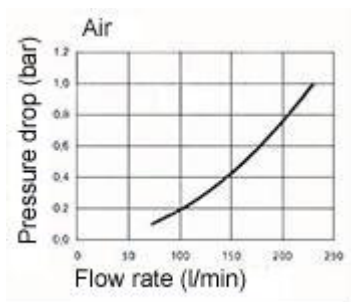

Quick disconnect coupling DN 2.7, stainless steel 1.4404, male

Type No.	Article No.	Connection	a/f mm	L mm	D mm	L1 mm
243.08/1-ES	107107	M5 male	9	26.0	10.0	5.0
243.08/2-ES	107108	G 1/8 male	11	28.0	10.0	7.0

Quick disconnect coupling DN 2.7, stainless steel 1.4404, female

Type No.	Article No.	Connection	a/f mm	L mm	D mm	L1 mm
243.08/3-ES	107109	M5 female	9	25.0	10.0	5.0
243.08/4-ES	107110	G 1/8 female	12	28.0	10.0	7.0

Quick disconnect coupling DN 2.7, stainless steel 1.4404, with hose stem

Type No.	Article No.	Connection	L mm	D mm	L1 mm
243.08/5-ES	107111	Stem, I.D. 3	35.0	10.0	13.0
243.08/6-ES	107112	Stem, I.D. 4	35.0	10.0	13.0

Quick disconnect coupling DN 2.7, stainless steel 1.4404, with hose connector

Type No.	Article No.	Connection	a/f mm	L mm	D mm	L1 mm	L2 mm	G mm
243.08/7-ES	107113	Hose connection 4x3	9	34.0	10.0	7.0	5.0	M7x0.5
243.08/8-ES	107114	Hose connection 5x3	9	34.0	10.0	7.0	5.0	M7x0.5
243.08/9-ES	107115	Hose connection 6x4	9	34.0	10.0	7.0	5.0	M8x0.5

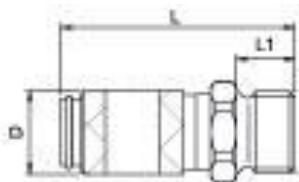

male

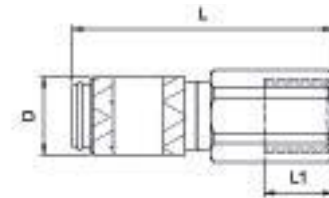

female



243.08/2-ES



243.08/4-ES

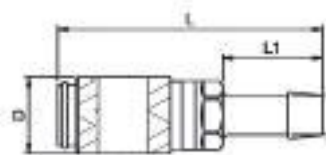

Hose stem

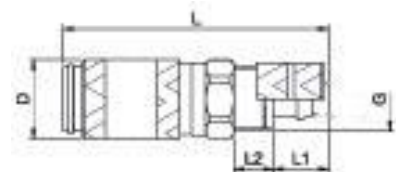

Hose connector



243.08/6-ES



243.08/8-ES

Stem for couplings DN 2.7, stainless steel 1.4404

Type No.	Article No.	Connection	L mm	D mm	L1 mm
243.09/1-ES	107116	Stem, I.D. 3	24.0	7.0	13.0
243.09/2-ES	107117	Stem, I.D. 4	24.0	7.0	13.0

Plug for couplings DN 2.7, stainless steel 1.4404, for hose

Type No.	Article No.	Connection	a/f mm	L mm	L1 mm	L2 mm	G mm
243.09/3-ES	107118	Plug for hose 4x3	8	25.0	7.0	5.0	M7x0.5
243.09/4-ES	107119	Plug for hose 5x3	8	25.0	7.0	5.0	M7x0.5
243.09/5-ES	107120	Plug for hose 6x4	8	25.0	7.0	5.0	M8x0.5

Plug for couplings DN 2.7, stainless steel 1.4404, male

Type No.	Article No.	Connection	a/f mm	L mm	L1 mm
243.09/6-ES	107121	Plug M5 male	7	17.0	5.0
243.09/7-ES	107122	Plug G 1/8 male	11	20.0	7.0

Plug for couplings DN 2.7, stainless steel 1.4404, female

Type No.	Article No.	Connection	a/f mm	L mm	L1 mm
243.09/8-ES	107123	Plug M5 female	7	17.0	5.0
243.09/9-ES	107124	Plug G 1/8 female	12	19.0	7.0

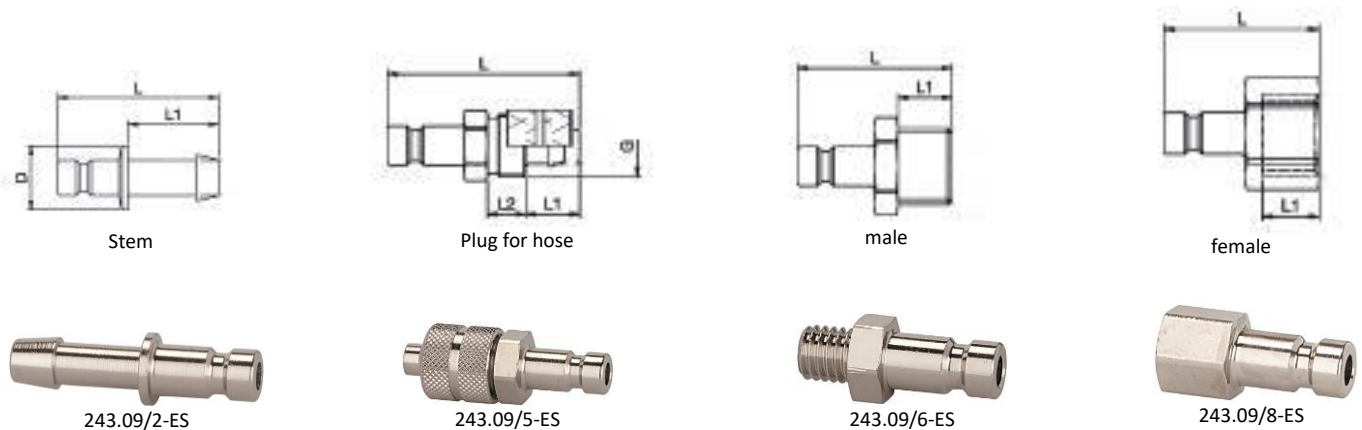

Installation location

The installation location of the quick-connect coupling must be selected so that the health of the person operating it cannot be harmed by sources of danger in the immediate surroundings, e.g. from slipping, jamming, contaminating or burning.

Low pressure applications

Threads for low-pressure applications are, if series-related no corresponding coatings or sealing rings are present, to be provided with suitable sealing materials, such as a PTFE belt or liquid sealing agent. Here the resistance to the flowing medium must be paid attention to.

Service manual

Quick-connect couplings are predominantly maintenance-free, if used in standard applications and handled carefully. The selection of the quick-connect coupling must be compatible with the intended purpose of use and material. Depending on the operating conditions it is recommended to provide the following points during maintenance:

External visual inspection with dirt in the functioning area of coupling and plug (seal area, control elements) these must be cleaned. The following distinguishing symptoms require replacement of the corresponding parts: Torn, damaged, heavily damaged or corroded parts, leaks on coupling and / or plug parts.

Function test under maximum Max. operating pressure can be used to test the quick-connect coupling for possible malfunctions and leaks. During the testing and operating phase it must be ensured that the operating personnel work protected.

Replacement intervals for quick-connect couplings must, if available, be adapted to the state or technical standards. However, also operating experiential values, which result from the required operational safety and the conditions of use, such as downtimes, coupling frequency, Max. operating pressure and properties of the medium, are critical for establishing the replacement intervals.

Pulsating tool

When using pulsating tools it is recommended to observe the standard ISO 6150, § 7.1. It recommends installing a minimum 300 mm long, flexible hose between the pulsating tool and the quick-connect coupling. The oscillating forces are taken by the hose piece and thus increase the service life of the quick-connect coupling. No warranty can be made for couplings mounted directly on pulsating tools.

Flow direction

The recommended flow direction is from the coupling to the plug if nothing else is specified in the technical data sheet.



Application with hoses

When using hoses the permissible Max. operating pressure and the working temperature must absolutely be observed and suitable hose connections must be seen to.